

HyDra Fleece System

- Montageanvisning under bottenplatta
- Installation manual for basement slab

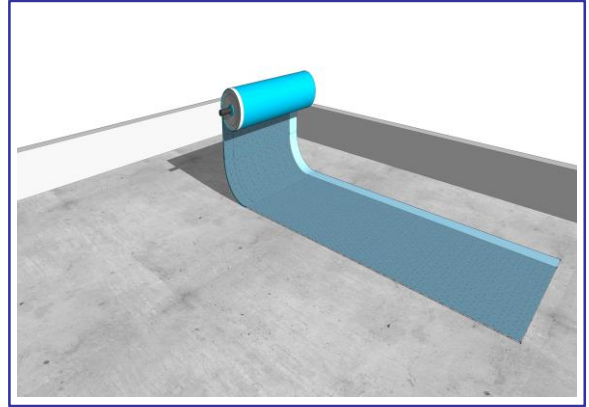

- Förbered underlaget inför membranmontage
- Preparation of base before installing membrane
- Underlaget skall vara väl packat utan vassa uppstickande föremål
- Compacted, clean planum without sharp objects



- Rulla ut HyDra Fleece-rollen 1,0 x 20,0m
- Roll out of HyDra Fleece-roll 1,0 x 20,0m

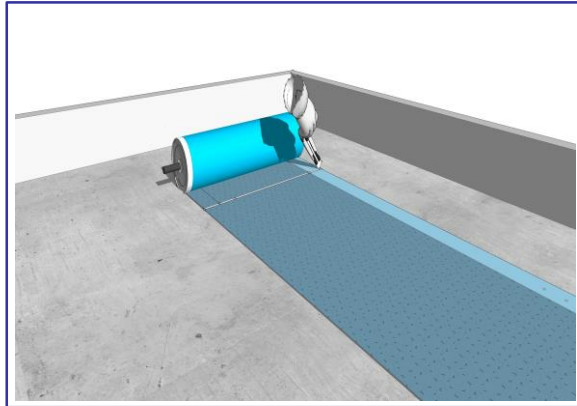

- Skär av med kniv eller sax
- Simple assembly with cutter knife and/or scissors

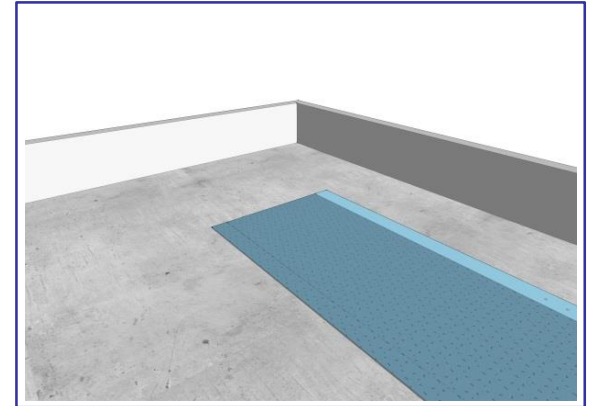

- Utrullad HyDra Fleece på välkompakterat underlag
- Rolled out HyDra-sheets on compacted planum

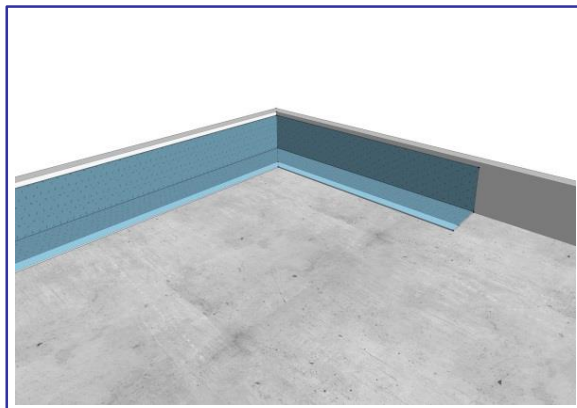

- Montera och fäst den manuellt beredda HyDra Fleece
- remsan längs formen (membranets bredd beroende på höjden på formningen PLUS 10 cm horisontell överlappning). Den horisontella överlappningen måste vara minst 10 cm.
- Fitting and securing of the manually prepared HyDra Fleece stripe along the side formwork (width of stripe depending on height of side formwork PLUS 10cm horizontal overlap). The horizontal overlap must be at least 10cm.

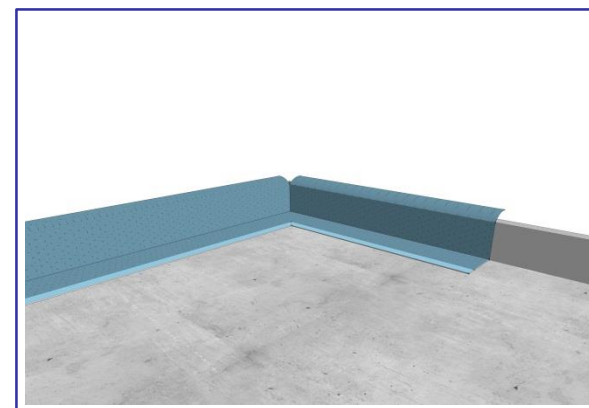

- Övergång platta/vägg: om HyDra Fleece ska eftermonteras på vägg vid senare skede skall ett 20 cm överlapp över formen lämnas. Den överlappande delen måste hållas fri från smuts och föroreningar.
- Connection slab-wall: to connect the slab-fleece to the vertical wall-fleece at a later stage a min. 20.0cm-overlap is left beyond the slab formwork. The overlap must be kept free from contamination!

HyDra Fleece System

- Montageanvisning under bottenplatta
- Installation manual for basement slab

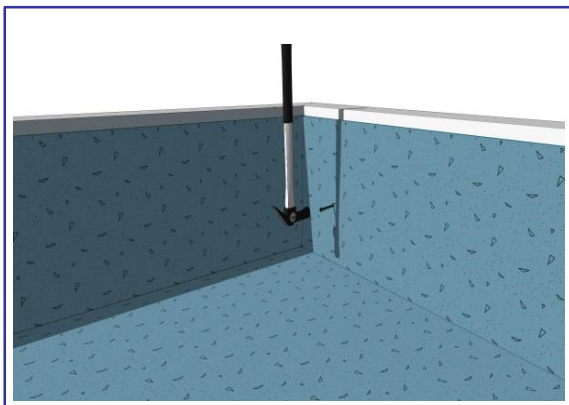

- Fäst HyDra Fleece mekaniskt på formen. OBS: Spiken ska endast fästas så att spiken inte följer med formen när den rivs. Spik med stort huvud rekommenderas.

- Mechanical fixing of the manually prepared HyDra Fleece- strips on the side formwork

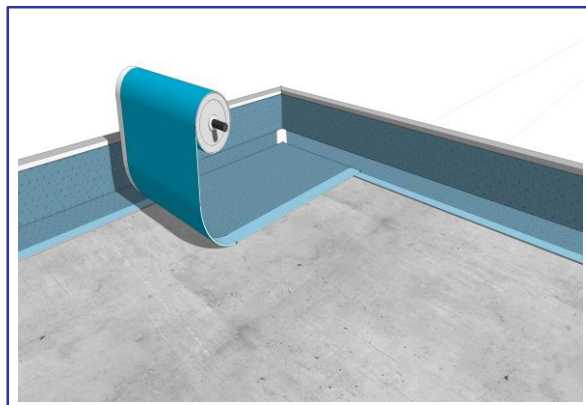

- Montera HyDra Fleece på den horisontella ytan utefter det redan installerade HyDra Fleece. Tillse att skarvtejp över/undersida monteras mot varandra. Se Bild 1 & 2 nedan.

- On horizontal surface connection of 1.0 x 20.0-sheets onto the previously on side formwork installed HyDra Fleece stripes. See picture 1 & 2 below.

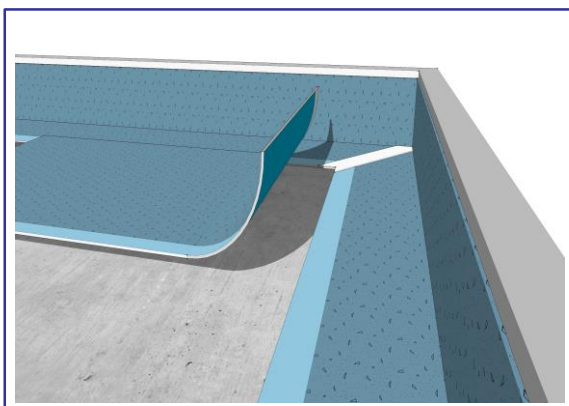

- 75 mm överlapp med förmonterade HyDra Fleece tejp. Se bild 1 & 2 nedan.

- 75mm overlap with preassembled HyDra Fleece adhesive tape.

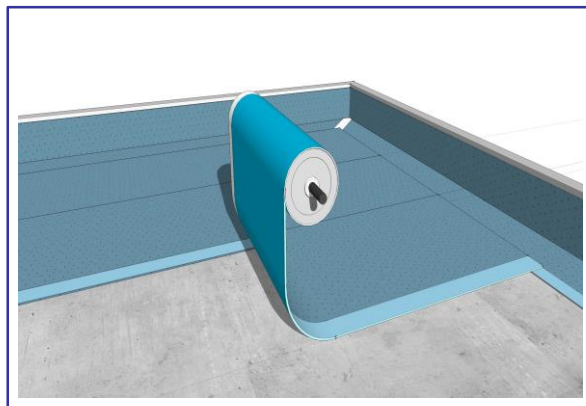

- Montage med HyDra Fleece rulle för rulle.

- Installation of Polyfleece SX®1000-rolls roll by roll



Bild 1: Montage överlapp / overlap



- Bild 2
Ta bort den vita och den blå skyddstejpen när HyDra Fleece har hamnat i rätt position
- Pull off of blue and white liner in one step after Polyfleece-rolls have been positioned

HyDra Fleece System

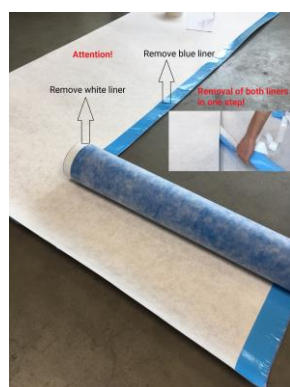
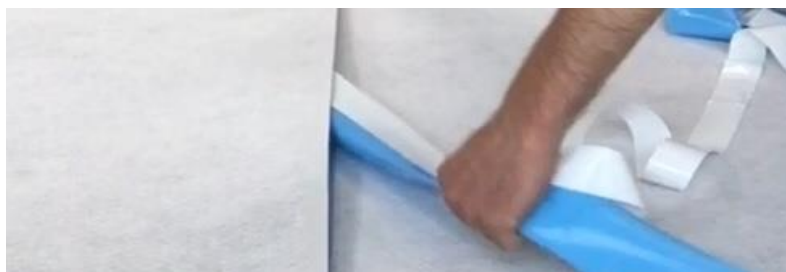
- Montageanvisning under bottenplatta
- Installation manual for basement slab

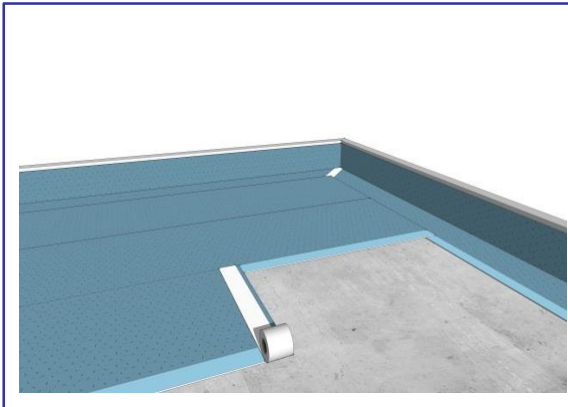

- När förtejpade skarvar vita/blå ej finns skall skarv utföras enligt följande:

Vid hörn och/eller ej förtejpade skarvar appliceras dubbelhäftande Polyfleece tejp ca. 25mm från kanten. Därefter tas skyddsfolien bort på dubbelhäftande tejen.

- If that is not possible following procedure must be carried out:

At corner and/or cross-/T-overlaps the self-adhesive Polyfleece SX®1000- tape 75mm is assembled at about 25mm from the frontside leaving a 25mm fleece-strip open. Subsequently removal of the protection foil.

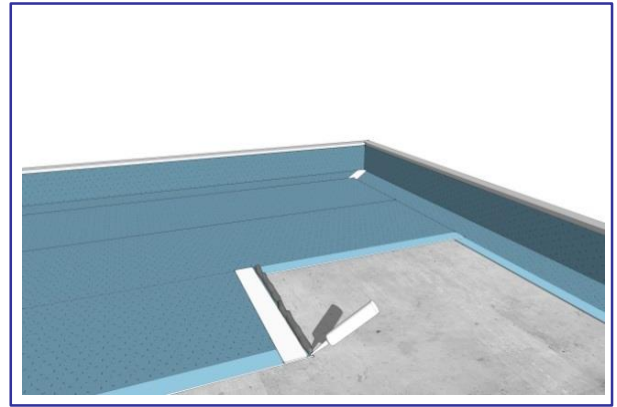

- Applicera en sträng Hydra Montagem Super X1 PLUS på den 25 mm breda delen som återstår vid skarvning.

- Additional bonding of the open fleece edge stripe with Contact adhesive Super X1 PLUS.

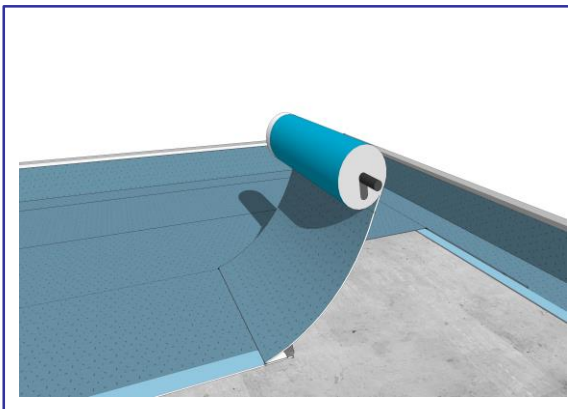

- Efter att skyddsfolien tagits bort från den självhäftande tejen läggs de två membran ihop med omlottskarv 100 mm så att membranet täcker både den Polyfleece dubbelhäftande tejp samt Hydra Montagem Super X1 Plus.

- After all PE-foils have been removed from the self adhesive tapes the two membranes are overlapped with 100mm covering both the self-adhesive tape and Contact adhesive Super X1 PLUS.

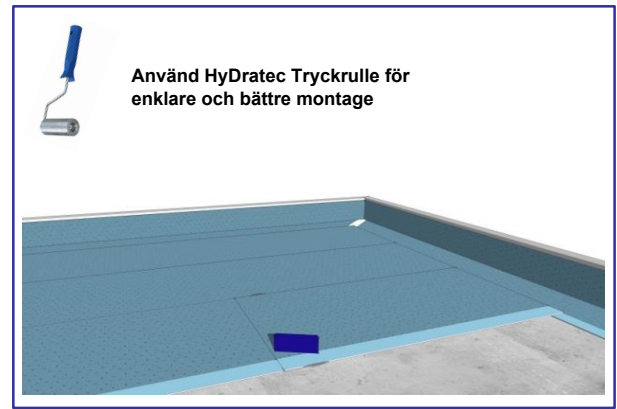

Använd HyDratec Tryckrulle för enklare och bättre montage

- Använd Hydratecs Tryckrulle vid alla skarvar. HyDratec Tryckrulle säkerställer att Hydra montagem Super X1 PLUS kommer i kontakt med båda membranerna.

- The use of HyDratec pressure roll ensures connection between both membranes so that Hydra Super X1 PLUS will be pressed on correct.

- Som tillägg kan PolyfleeceSX 1000 fleecetape användas där så önskas.

- Optional the seam can be secured with Polyfleece SX®1000 fleece tape

General application rules for installing waterproofing membrane HyDra Fleece membrane:

- Application temperature HyDra Fleece membrane is between -10°C and +40°C, respectively -5°C/+30°C (construction device temperature). Before pouring the concrete onto the membrane this must be free of ice and standing water.
- Before pouring the concrete and after removal of formwork Polyfleece SX® 1000 needs to be undertaken a supervision. Defects must be repaired with HyDra Fleece membrane- patches in combination with Contact adhesive Super X1 PLUS and Polyfleece SX® 1000 adhesive tape.
- Pollution of the membrane must be removed mechanically before concrete pour. Otherwise this will influence the intergral bond of the membrane to the concrete negatively.
- Stiffness of the concrete must be >10N/mm², respectively adhesive tensile strength of the membrane to the concrete >0,2N/mm² before removal of formwork. Under normal circumstances both criteria are fulfilled when formwork is removed earliest after 48 hours.
- Concrete must have consistency F4 and comply with C20/25.
- Concrete pour is recommended to be done according to corresponding national standard (Germany: DIN 1045-2, DIN EN 206-1)